

Varenummer: 03552030

Beskrivelse: Fluro hydraulik ledhoved FPR 30N

Mål

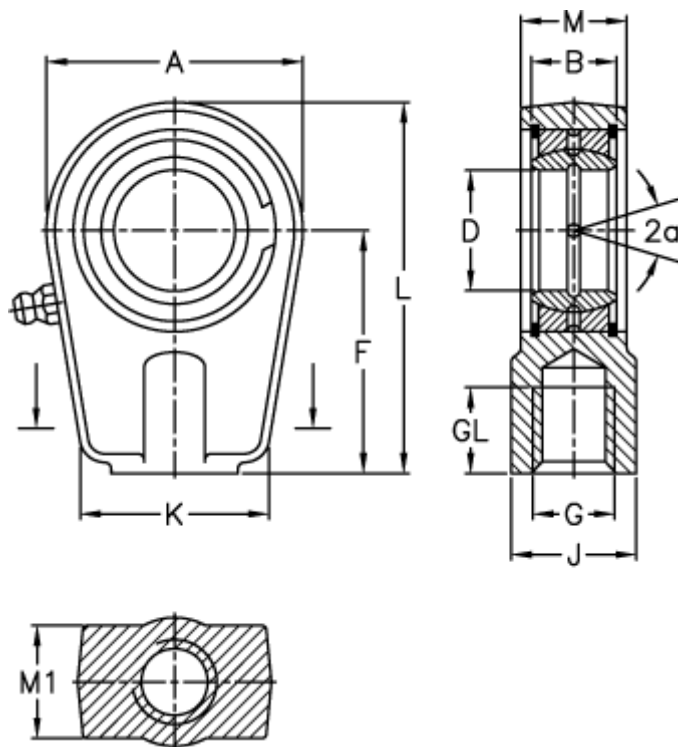

A	= 64	J	= 32
a (grader)	= 6	K	= 50
B	= 22	L	= 94
D	= 30	M	= 28
Dynamisk belastning C (kN)	= 62	M1	= 26
F	= 60	Statisk belastning C0 (kN)	= 106
g	= M22x1,5	Vægt	= 700
GL	= 23		